

HYPERION ONE

INFRARED LED ILLUMINATOR



**ENERGY
SAVING**



**VANDAL
PROOF**



**WALL / HOUSING
MOUNT BRACKET**



**IP66 & IP67
RATING**



**NO EXTERNAL
PSU**



**DAY/NIGHT
SWITCH**



**MAINTENANCE
FREE**

High Power

The latest smt led technology dare high performance and low power consumption

Ready for wall or camera housing

Easy to install, compatible with any camera housing! Wall/Housing bracket included.

Integrated power supply and twilight

The integrated constant current power supply and photocell circuit allow a quick and easy installation without external box

Moulded full Aluminium body

The sturdy Aluminium body guarantees vandalproof performances as well as heat dissipation



tekno system®

Italian design for CCTV since 1979

Tekno System S.p.A.

Via Rostoncello, 1 - 36010 Carrè - Italy

Phone: +39 0445 314324 | Fax: +39 0445 314319

Email: info@teknoystem.eu | Web: www.teknoystem.eu

rev. 080610

Page 1 / 4

SPECIFICATION

General

- Wavelength: 850nm semi-covert
- High efficiency SMT Leds
- PC optical beam collimator
- Aluminium die cast molding and Technopolymers
- Radiant body for optimal thermal yield

Mechanical

- Dimensions: 192 x 195 x 83 mm
- Angle adjustable: NO
- Beam Pattern: see table
- 2 Cable Glands M16 x 1,5 ; precabled (2mt)

Electrical

- Wide range power supply: 230 V~
- Power: 16 W (HI version)
10 W (LOW version)
- Adjustable Photocell circuit
- Dry contact for Day/Night camera switch

Environmental

- Indoor / Outdoor applications
- IP66 and IP67 weatherproof rating (EN60529)
- Temperature Range : -50°C to 50°C
- RoHS compliant
- CE



Technical data and product features might be modified without any warning.



tekno system[®]
Italian design for CCTV since 1979

Tekno System S.p.A.
Via Rostoncello, 1 - 36010 Carrè - Italy
Phone: +39 0445 314324 | Fax: +39 0445 314319
Email: info@teknoystem.eu | Web: www.teknoystem.eu

rev. 080610

Page 2 / 4

MODELS

ORDER CODE	Beam Angle	Max Distance		IP Rate	Power supply	Wall / Housing Bracket
HYP1 15 HI	15°	150 m	(164 yd)	IP66/67	Internal 230 V~	●
HYP1 30 HI	30°	100 m	(109 yd)	IP66/67	Internal 230 V~	●
HYP1 60 HI	60°	70 m	(77 yd)	IP66/67	Internal 230 V~	●
HYP1 120 HI	120°	35 m	(38 yd)	IP66/67	Internal 230 V~	●
HYP1 30 LOW	30°	55 m	(60 yd)	IP66/67	Internal 230 V~	●
HYP1 60 LOW	60°	35 m	(38 yd)	IP66/67	Internal 230 V~	●
HYP1 120 LOW	120°	18 m	(20 yd)	IP66/67	Internal 230 V~	●

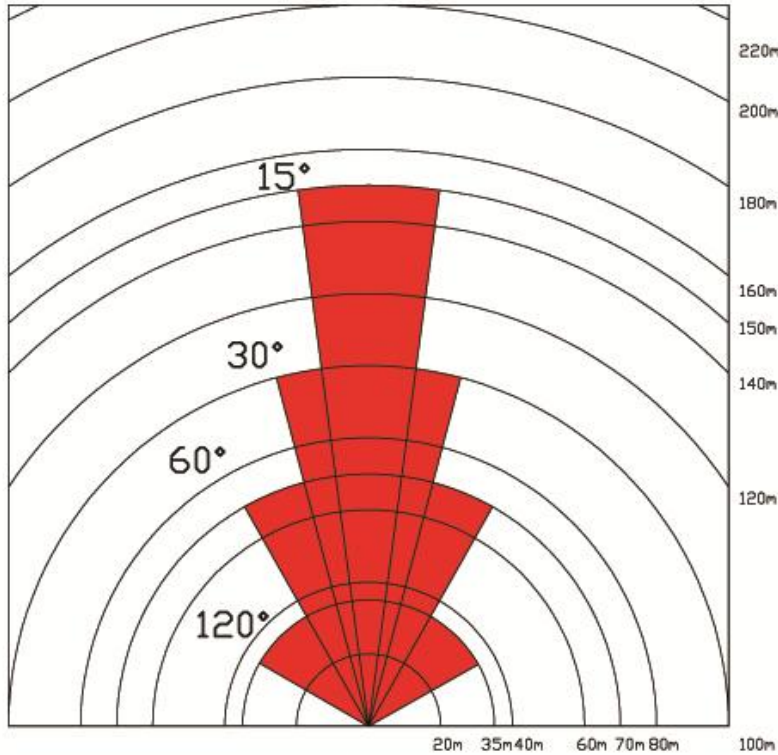

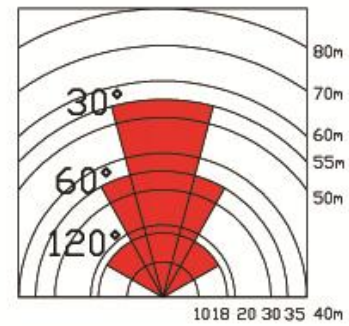

HYP1 HI





HYP1 LOW

ACCESSORIES

BWHYP1	Optional Wall Bracket for HYPERION ONE	
BWRHYP1	Hyperion One Adapter for LINEA R Camera Housing	

RELATED PRODUCTS

PA/1 (*)	Pole mount adapter for one bracket	
PA/2 (*)	Pole mount adapter for two brackets	
CM (*)	Corner mount adapter	

(*) These adapters need the BWHYP1 Optional Wall Bracket for HYPERION ONE



tekno system[®]
Italian design for CCTV since 1979

Tekno System S.p.A.
Via Rostoncello, 1 - 36010 Carrè - Italy
Phone: +39 0445 314324 | Fax: +39 0445 314319
Email: info@tekno-system.eu | Web: www.tekno-system.eu

rev. 080610

Page 3 / 4

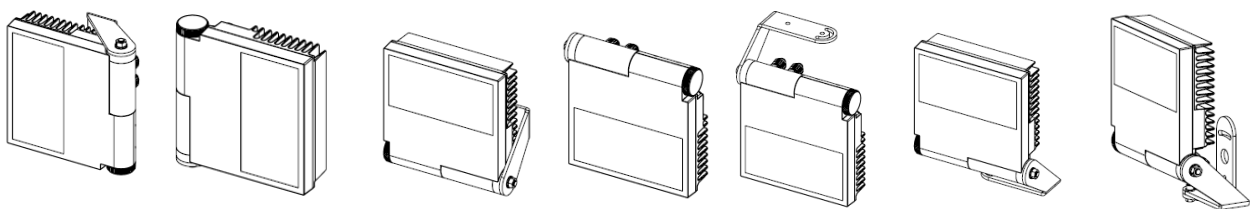
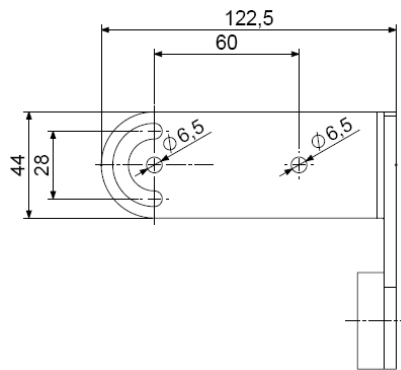
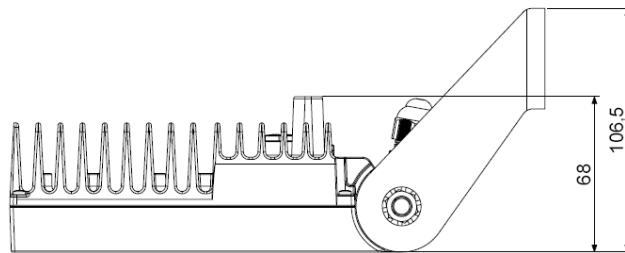
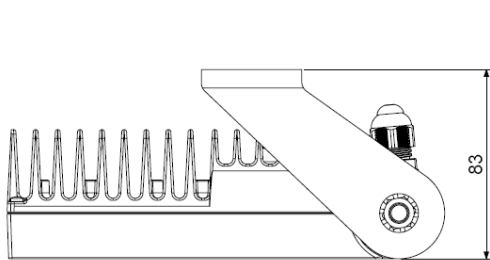
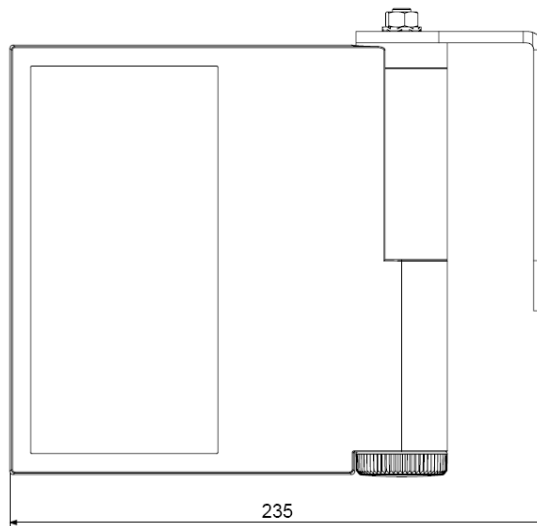
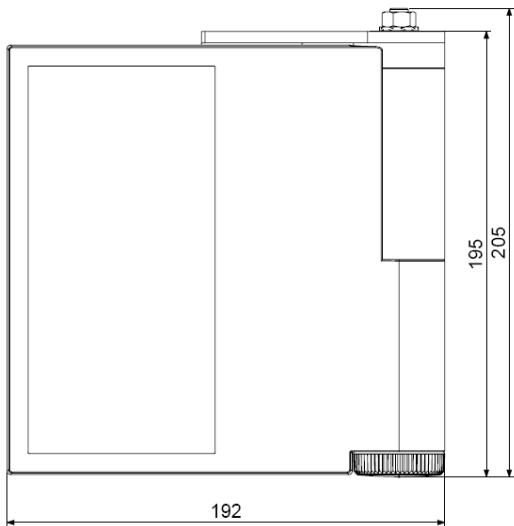

tekno system[®]
Italian design for CCTV since 1979

Tekno System S.p.A.
Via Rostoncello, 1 - 36010 Carrè - Italy
Phone: +39 0445 314324 | Fax: +39 0445 314319
Email: info@teknoystem.eu | Web: www.teknoystem.eu

rev. 080610

Page 4 / 4